

# SciPlus-3500

*Graphing Scientific Calculator with Speech Output*

Copy downloaded from  
[www.sightenhancement.com](http://www.sightenhancement.com)

For a high-quality spiral bound copy please  
contact Sight Enhancement Systems

User Guide



## Table of Contents

Getting Started .....	1
Charging your SciPlus-3500 .....	2
Auto Shutoff .....	2
The SciPlus-3500 Display .....	3
SciPlus-3500 Operations.....	4
Soft Keys .....	4
A Note Regarding Nomenclature: .....	4
Working with Previous Results .....	5
Implied Operators .....	5
Speech Output.....	5
Settings .....	6
Basic Functions .....	10
Mathematical Functions.....	12
Trigonometry .....	14
Converting Angles .....	15
Converting Coordinates between Polar and Rectangular.....	16
Working With Fractions.....	17

Memory Operations .....	18
Statistical Operations .....	20
Using the SciPlus-3500 to Evaluate Mathematical Functions .....	22
Graphing with Your SciPlus-3500 .....	27
Errors.....	34
Troubleshooting .....	35
Service .....	36
Warranty .....	36



## Getting Started

Your SciPlus-3500 calculator performs a wide variety of mathematical, statistical, and trigonometric calculations. The speech output provides an audible description of all operations.

The SciPlus-3500 also enables you to evaluate and graph mathematical functions.

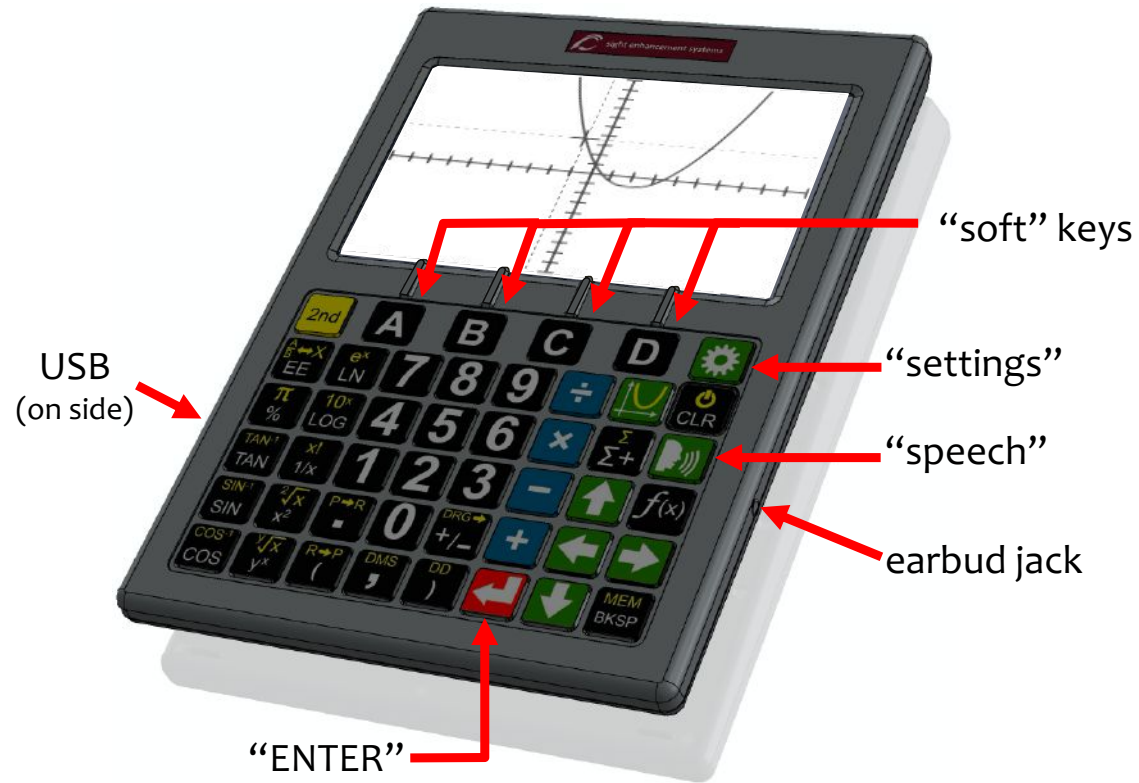
This User Guide will explain how to get the best from your calculator. Let's first get familiar with the SciPlus-3500 controls.



**Learning Mode:** If you press and hold  for five seconds the SciPlus-3500 enters “Learning Mode”. In this mode, the keys do not operate normally. Rather, they simply announce (through the earbuds) their function. This allows you to become comfortable navigating the keyboard. If you precede a key with  it will speak its alternate function if one exists. Press and hold  again to return to normal operation.

## Charging your SciPlus-3500

Charging the calculator is easy. Your SciPlus-3500 calculator includes a USB Wall Charger and cord. Simply plug the USB wall charger into a regular outlet, and plug the USB cable into the SciPlus-3500. The calculator should fully charge overnight. On a full battery the SciPlus-3500 will operate for about 6-8 hours of continuous use. Note this is less than an ordinary calculator because of the bright backlight, which makes the display much easier to read.

When the SciPlus-3500 is charging, you will notice the battery symbol is animated. The battery is completely charged if when the animation stops and three solid bars are shown. When the battery requires recharging, you will hear a beep in your earbuds every 30 seconds.

**Note:** If your SciPlus has been unused for a very long time, you may need to charge it for a while before it will even turn on. When this happens, make sure you “RESET” the SciPlus by carefully inserting a paperclip into the hole on the backside of the calculator. This restores factory settings to ensure proper operation.







## Auto Shutoff

Your SciPlus-3500 calculator will automatically shut off after a few minutes of inactivity. Many of the calculator’s current settings such as the angle mode, number format, etc., will be saved, so that it will turn on again in the same state. Values stored in memory and the statistics table are also saved.

If the calculator is left off for an extended period (typically many weeks), these settings may be lost.

## The SciPlus-3500 Display

The SciPlus-3500 screen has four lines. The bottom line with the flashing red cursor is where you enter expressions. The other three lines show the results of previous operations. Once you press  an expression is evaluated and its result is moved up a line, leaving the bottom line empty to enter another expression.

**Note:** When lengthy expressions or results do not fit on the screen you will notice a  or  as shown in the diagram. This is to indicate that characters are hidden to the left or right. Use the     keys to move the cursor. In expressions use the backspace key  to delete what is to the left of the cursor and edit the expression.

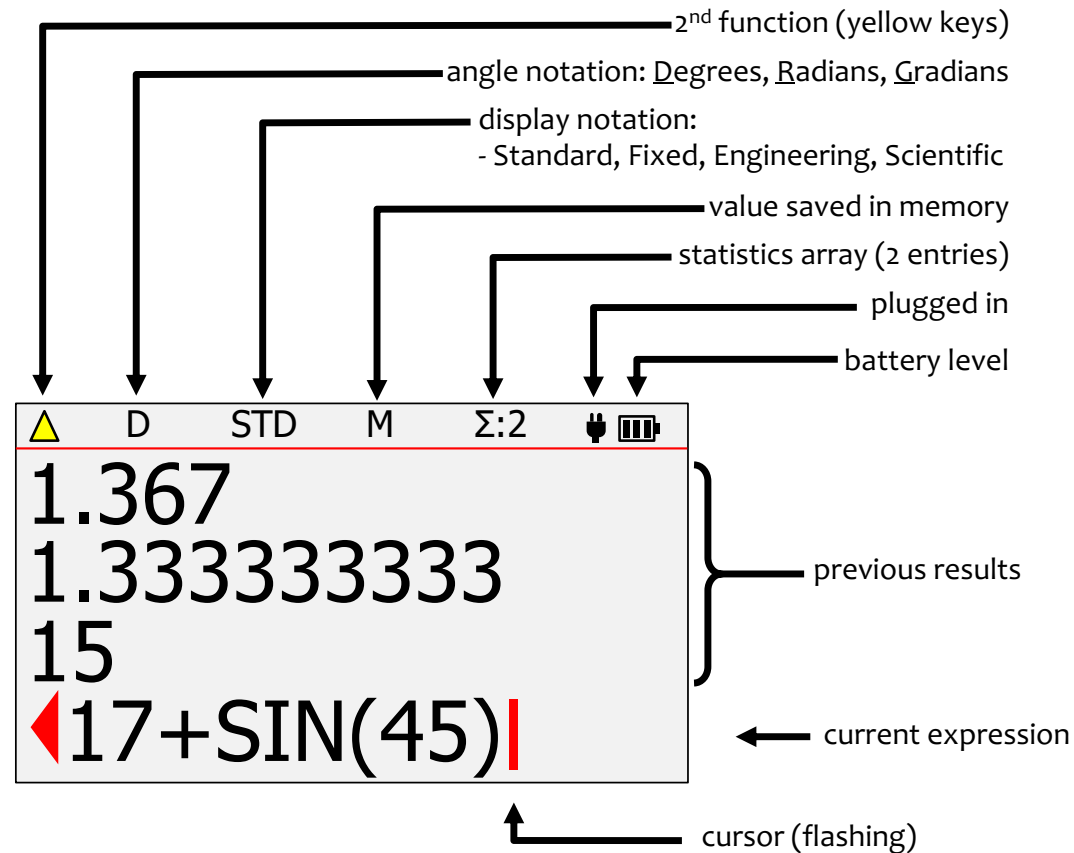



The characters above the horizontal red line at the top of the screen show the **status line** of the calculator. If the battery symbol is animated, this indicates that the battery is being charged. Some of the characters in the status line may not appear at all times. For example, if there is no entry in memory, or if the statistics register is currently empty, these items will not appear.







## SciPlus-3500 Operations

The SciPlus-3500 follows the “BEDMAS” rule for order of operations:







Brackets → Exponents → Divide → Multiply → Addition → Subtraction

Many of the SciPlus-3500 keys have two functions. The lower function appears in a white font. The alternate function appears in a yellow font. To access this function, the  key must first be pressed. You will notice a yellow up arrow  in the status line when you do this. Throughout the key descriptions below, if a key symbol appears in a yellow background, this indicates that the  key must be used.

## Soft Keys





The keys     do not have a specific function. Instead, labels at the bottom of the display define the function of these keys. If there are no labels, these keys will not do anything. You will use these keys when adjusting the SciPlus-3500's settings, and for memory and statistics operations, and when using the function (  ) and graphing (  ) features.

## A Note Regarding Nomenclature:

Throughout this manual, a key press is indicated either by the key image or a boldface blue character. For example,  indicates the  key on the keyboard. Note that sometimes boldface blue characters might be implemented using the SciPlus-3500's soft keys    .



## Working with Previous Results



When entering expressions in the bottom line, it's very easy to use the results of previous calculations displayed in the lines above it. Using the   keys, position the cursor at the location in the expression where you wish to insert a previous result. Now, using the   keys, select the previous result that you wish to insert into the current expression, and press .

## Implied Operators



In some cases there is no need to enter  in an expression. Here are some examples:

$$\begin{aligned}
 2 (3+1) & \text{ is the same as } 2 \times (3+1) \\
 2 \sin(30) & \text{ is the same as } 2 \times \sin(30) \\
 2 \pi & \text{ is the same as } 2 \times \pi \\
 (3 + 2) (7 - 3) & \text{ is the same as } (3 + 2) \times (7 - 3)
 \end{aligned}$$

## Speech Output



Your SciPlus-3500 will automatically read the results of expressions when they are evaluated. You will also notice that the speech output describes settings screens, etc., when they appear. At any time, pressing a button to continue operations will halt the speech output. To replay previous results, simply use the  key to highlight the line to be read, and select .

Turn speech output on/off:  

Read status line:  

**HINT:** Always ensure that the volume control on your ear buds is turned

## Settings

There are five settings screens in the SciPlus-3500, accessed by the  key. Cycle through the settings screens using  , or by entering **1** through **5**. Change settings using the **A B C D** keys.

### Number Format (Settings Screen #1)

There are four number formats supported by the SciPlus-3200:

<b>1</b>				NUM FORMAT			
STD		0 1 <b>2</b> 3 4		FIX		5 6 7 8 9	
<b>SCI</b>				ENG			
↑	↓	-	+				
<b>A</b>	<b>B</b>	<b>C</b>	<b>D</b>				

#### Standard:

Numbers show up to ten-digit precision.

Examples: 101, 41250.5, 0.3333333333

#### Fixed Notation:

Number of decimals is fixed.

Examples: 101.00, 41250.50, 0.33

#### Scientific Notation:

Numbers are displayed in powers of ten, with a fixed number of decimals.

Examples: 1.01E+02, 4.13E+04, 3.30E-01

#### Engineering Notation:

Numbers displayed in powers of ...  $10^{-6}$ ,  $10^{-3}$ ,  $10^0$ ,  $10^3$ ,  $10^6$ ..., with fixed decimal precision. These steps express values corresponding with “micro, milli, kilo, mega, etc.”.

Examples: 101, 41.25E+03, 333E-03

Screen Color Options (Settings Screen #2)

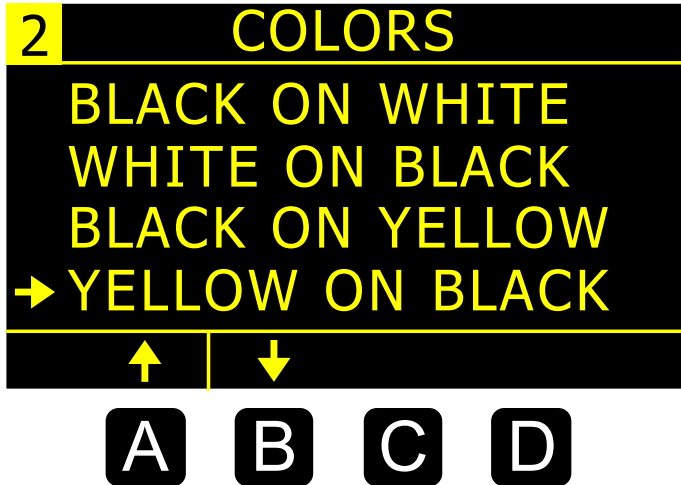

Often, people with low vision are able to benefit from different color options. Use **A** and **B** to scroll through the available options.

As you scroll through the options you will notice the calculator display changes accordingly.

Highlight Color Options (Settings Screen #3)

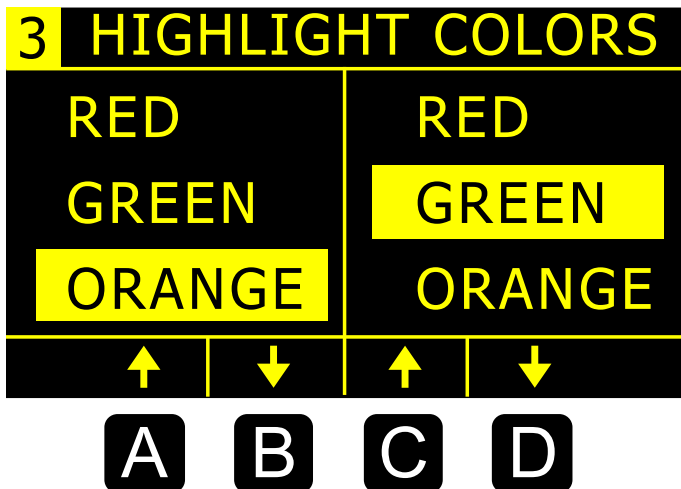

Highlight colors are used for items like the cursor and overflow arrows.

Use **A** and **B** to select highlight color #1.

Use **C** and **D** to select highlight color #2.

### Backlight Brightness (Settings Screen #4)

<b>4</b> BACKLIGHT			
		1 2 <b>3</b> 4	
		-	+
<b>A</b>	<b>B</b>	<b>C</b>	<b>D</b>

Use the **C** and **D** softkeys to adjust the brightness of the backlight. Maximum brightness will create the most contrast in brightly lit environments. Lowering the brightness will extend the battery life between charging

### Audio Output (Settings Screen #5)

<b>5</b> AUDIO			
<b>ENGLISH</b>	VOLUME		
FRANCAIS	1	2	<b>3</b>
ESPANOL	4	5	<b>6</b>
	7	8	9
↑	↓	-	+
<b>A</b>	<b>B</b>	<b>C</b>	<b>D</b>

The SciPus-3500 can operate in English, Spanish, French, and Arabic.

Use the **A** and **B** softkeys to select the language.

The **C** and **D** softkeys adjust the output volume.

Angle Mode (Settings Screen #6)

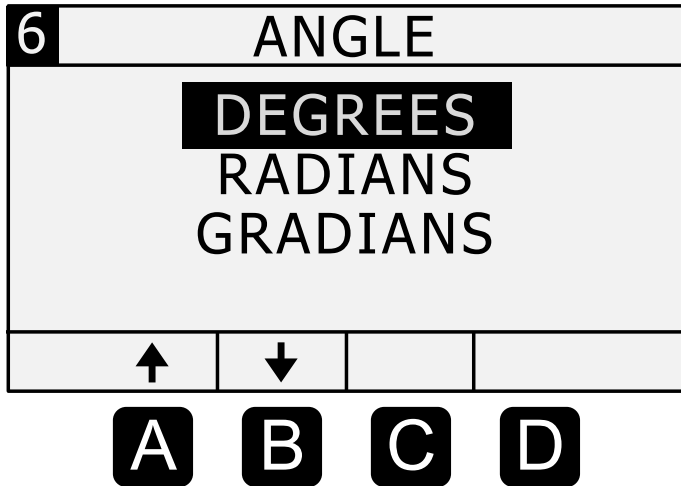





Use the **A** and **B** softkeys to select the angle mode.









Trigonometry functions and graphing will use degrees, radians, or gradians based on this setting.

You will see “D”, “R”, or “G” in the status line.











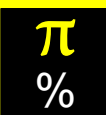



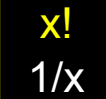
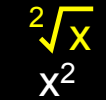

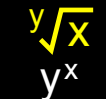

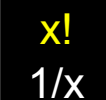



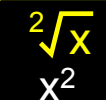

## Basic Functions

The tables below describe the functions of the SicPlus-3500 calculator. Note that several examples are included. You will find that some functions automatically introduce a left bracket “(”, indicating that you need to enter an expression, which could be as short as a simple number, or a long mathematical expression. For these functions you must close the expression with a right bracket “)”.











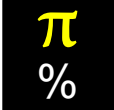











KEY	NAME	DESCRIPTION
	2 <sup>nd</sup> Function	Press this key before any dual-function key to access the upper (yellow) function. You will notice the  symbol flashing in the status line. <b>Note:</b> In this table, if the key symbol at right appears on a yellow background, the description applies to the upper (yellow) function.
	ON/Clear	Turn calculator ON. The cursor will appear on the bottom line. Most of the settings from the previous session will remain as they were. If the calculator is already on this key clears the bottom line.
	OFF	Save settings, memory and statistics data, and turn calculator OFF.
	Backspace	Delete last entry or function.

KEY	NAME	DESCRIPTION
	Enter ( = )	Resolves the current expression, displaying the result in the second line. If the expression contains errors, an error message will appear.
	Clear Screen	 then  clears the current expression and all previous results.
	Open Parentheses	Open parentheses. <b>Note:</b> Some expressions automatically include the opening parentheses.
	Close Parentheses	Close parentheses.
	Change Sign	Change the sign of the operand. After some operators (e.g. $\times$ $\div$ ), this operation will insert a negative sign into the expression.
	Scientific Notation	This is equivalent to “ $\times 10$ raised to the power...”
	Settings	Manage settings (see section on Settings). Toggles on/off.

## Mathematical Functions















KEY	NAME	DESCRIPTION
	Pi	Enters the symbol $\pi$ into an expression. If you press   then  the result 3.141592654 will be displayed.
	Factorial	Calculates the factorial of the value to the left. Enter this <i>after</i> you enter the value of 'x'.
	$x^2$	Squares the value to the left. Enter 'x' first. e.g.: <b>10</b>  followed by  yields a result of $10^2$ , or 100.
	$y^x$	Raises the value to the left, to an exponent. Enter 'y' first. Shown as '^'. e.g.: <b>2</b>  <b>3</b> followed by  yields a result of $2^3$ or 8.
	Reciprocal	Calculates the reciprocal of an expression in brackets. e.g.:  <b>25</b>  <b>4</b>  followed by  yields $1/100$ , or 0.01.
	Square Root	Calculates the square root of a value. e.g.:   <b>4</b> followed by  yields $\sqrt{4}$ , or 2.
	$n^{\text{th}}$ Root	Calculates the $n^{\text{th}}$ root of a value. e.g.: <b>3</b>   <b>8</b> followed by  yields the $\sqrt[3]{8}$ , or 2.
	LOG	Calculates the base10 logarithm of an expression in brackets. e.g.:  <b>25</b>  <b>4</b>  followed by  yields $\log_{10}(100)$ , or 2.



KEY	NAME	DESCRIPTION
	Percentage	<p>The behavior of the % function depends upon context.</p> <p>If the expression is simply a number with the % operator, the result of the expression is the number divided by 100.</p> <p>If the % operator is appended to a number which is itself to the right of the + - × or ÷ operator, the percentage is added to, subtracted from, multiplied by, or divided by the number to the left of the operator.</p> <p>e.g.: <b>3</b>  <b>50</b>  followed by  yields a result of 4.5.</p> <p>If used in a larger expression the operand must be enclosed in brackets.</p> <p>e.g.:  <b>(</b> <b>3</b>  <b>50</b>  <b>)</b>  <b>1</b>  results in 5.5</p> <p>If  is followed by any operator without a preceding closing bracket as shown above example, a Syntax Error will result.</p>
	LN	<p>Calculates the natural logarithm of an expression.</p> <p>e.g.:  <b>25</b>  <b>4</b> <b>)</b> followed by  yields ln(100), or 4.605170186.</p>
	$e^x$	<p>Calculates the value of e (2.2718282) raised to an expression.</p> <p>e.g.:   <b>2</b>  <b>3</b> <b>)</b> followed by  yields <math>e^5</math>, or 148.4131591.</p>
	$10^x$	<p>Calculates the value of 10 raised to a value.</p> <p>e.g.:   <b>5</b> followed by  yields <math>10^5</math>, or 100000.</p>

















## Trigonometry

Trigonometry functions are very straightforward with the SciPlus-3500. Note that the values used in trigonometry functions, and the result, are expressed in Degrees, Radians, or Gradians, as indicated by ‘D’ ‘R’ or ‘G’ in the status line. The examples shown below assume the SciPlus-3500 is in “DEGREES” mode.















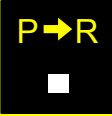

KEY	NAME	DESCRIPTION
 	Sine	Calculates the sine of an expression. e.g.:  <b>30</b>  followed by  yields 0.5.
 	Arcsine	Calculates the inverse sine (arcsine) of an expression. e.g.:   <b>0.5</b>  followed by  yields 30.
 	Convert Angle	  converts the current value displayed in the <b>second line</b> , and changes the status line parameter.

The Cosine and Tangent functions, and their inversions, work the same way.





## Converting Angles

KEY	NAME	DESCRIPTION
	Decimal Degrees to DMS	<p>Converts decimal degrees into degrees, minutes, seconds.                      e.g.:   <b>45.5</b>  followed by  yields (45,30,0.00).</p> <p>Note that if the second line is in DD format, entering   followed by  converts that value into DMS format.</p>
	DMS to Decimal Degrees	<p>Converts degrees, minutes, seconds into decimal degrees.                      e. g.:   <b>45,30,0</b>  followed by  yields (45.5)</p> <p>Note that if the second line is in DMS format, entering   followed by  converts that value into DD format.</p>

## Converting Coordinates between Polar and Rectangular



KEY	NAME	DESCRIPTION
	Rectangular to Polar	<p>Converts rectangular (x,y) coordinates into polar (r,θ). Note that angles are expressed in degrees, radians or gradians as indicated on the status line.</p> <p>e.g.:   <b>1 , 1</b>  followed by  yields (1.41,45.00)</p> <p>Note that if the result line is in rectangular (x,y) format, entering   followed by  converts that value into polar (r,θ) format.</p>
	Polar to Rectangular	<p>Converts polar (r,θ) coordinates into rectangular (x,y). Note that angles are entered as degrees, radians or gradians as indicated on the status line.</p> <p>e.g.:   <b>1.41 , 45</b>  followed by  yields (1.00,1.00)</p> <p>Note that if the second line is in polar (r,θ) form at, entering   followed by  converts that value into rectangular (x,y) format.</p>

## Working With Fractions

KEY	NAME	DESCRIPTION
	Enter a Fraction	<p>Use this key to enter a fractional amount into an expression. The result is displayed as a fractional amount ONLY if all the operands in the expression are entered as either fractions or integer numbers.</p> <p>e.g.: <math>2 + 2^{\text{nd}} \frac{4}{3} \div 6</math> followed by  yields 6 1/2</p> <p><math>2.0 \frac{4}{3} \div 6</math> followed by  yields 6.5</p> <p><b>Note:</b> If no whole number component and comma (“4 ,” in the examples above is entered it is assumed that the whole number component of the fraction is zero.</p> <p>e.g.: <math>2.0 \frac{3}{6}</math> followed by  yields 2.5</p>
	Convert Between Fraction and Decimal	<p>Pressing <math>2^{\text{nd}} \frac{A}{B} \leftarrow</math> without any arguments converts the contents of the second line from fraction to decimal (or vice versa).</p>

## Memory Operations

Note that some memory operations with the SciPlus-3500 use the soft keys **A B C D**.

KEY	NAME	DESCRIPTION
	Display Memory Soft Keys	 causes the memory soft keys to be displayed. Note that there are two sets. Pressing  a second time will bring up the second set of memory soft keys. A third time will disable the soft keys.

Soft keys **A B C D** are used to clear the memory, swap the value in memory with the current line, and perform simple arithmetic operations ( + - × ÷ ) on the value stored in memory using the current line. Memory soft keys are shown on the opposite page. In this example, the value ‘15’ resides in the current line. Note that storing a value of ‘0’ clears the memory.

Note that the **STO** ( **A** ), if pressed at the end of an expression, will solve the expression and store the result. **EXC M+ M- M×** and **M÷** all work in the same manner.

Pressing the **RCL** ( **B** ) will add “RCL” to the current expression. When the expression is evaluated, the value currently stored in memory is used. To display the value currently in memory, simply enter **RCL** by itself, followed by .





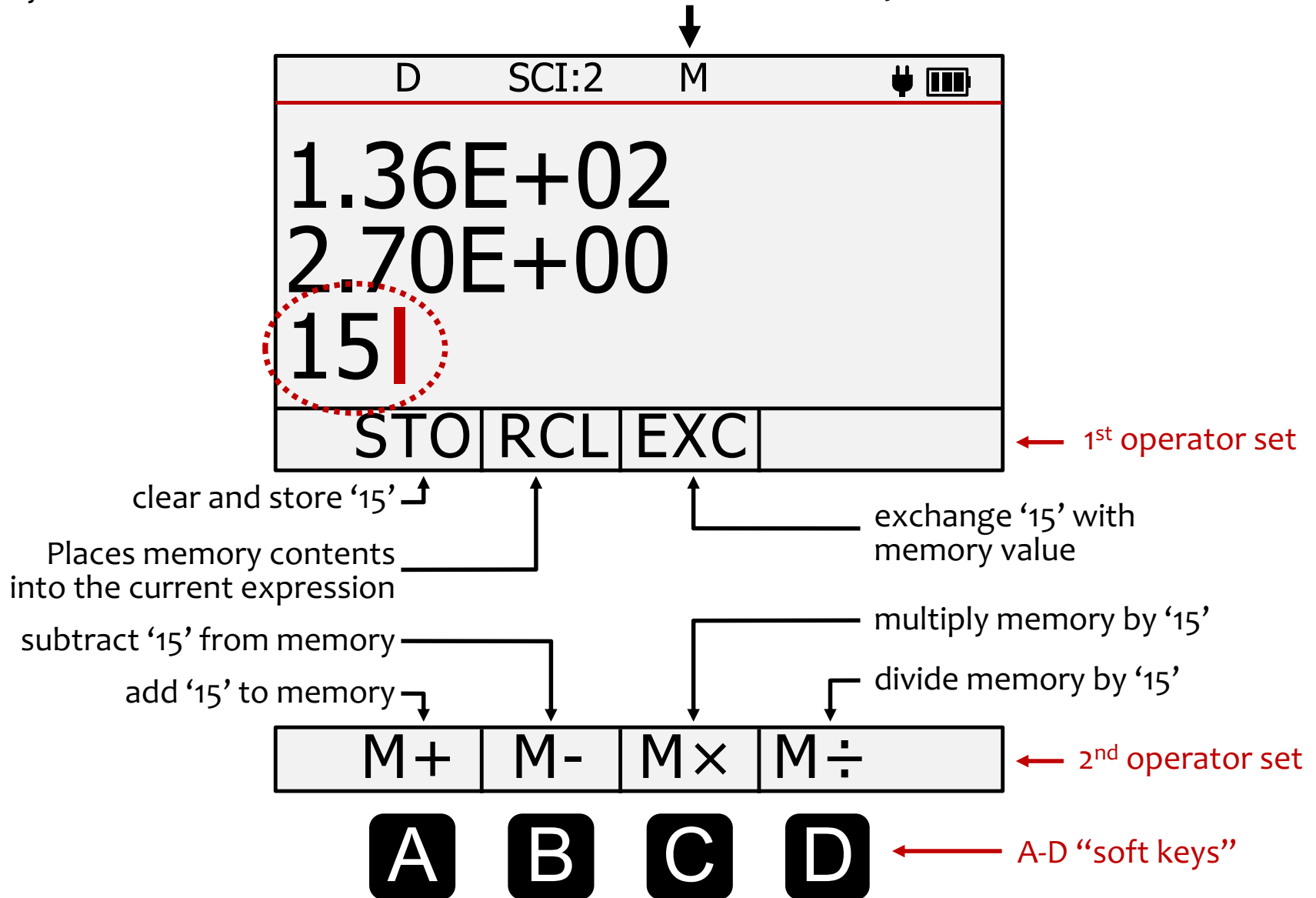





Memory Soft Keys:



“M” indicates there is a value in memory



## Statistical Operations

The SciPlus-3500 performs statistical operations on a table of up to 99 entries. Note that most statistical operations with the SciPlus-3500 use the soft keys **A B C D**.

KEY	NAME	DESCRIPTION
	Add Data Point in Stats Register	<p>Adds the current value into the statistics table. If pressed at the end of an expression, the expression is solved, and the result added. Note that if a value already exists in the table, it will be added a second time.</p> <p>e.g.: <b>2</b>  <b>3</b>  <b>5</b>  <b>3</b>  will create a table (2, 3, 5, 3)</p>
	Display Statistics Soft Keys	<p>  causes the statistics soft keys to be displayed. Note that there are two sets. Pressing   a second time will bring up the second set of soft keys. A third time will disable the soft keys.</p>

Soft keys **A B C D** are used to perform various statistical operations. Statistics soft keys are shown on the opposite page. Just enter the soft key followed by  to display that value in the second line. For example, for the table (2, 3, 5, 3), selecting **C**  will show the mean value 3.25.

**Note:**  $\mu$ ,  $\Sigma(x)$ ,  $\Sigma(x^2)$ ,  $\sigma$ ,  $\sigma^2$  and **M** can all be used in expressions.



Statistics Soft Keys:

indicates there are two entries in the statistics table

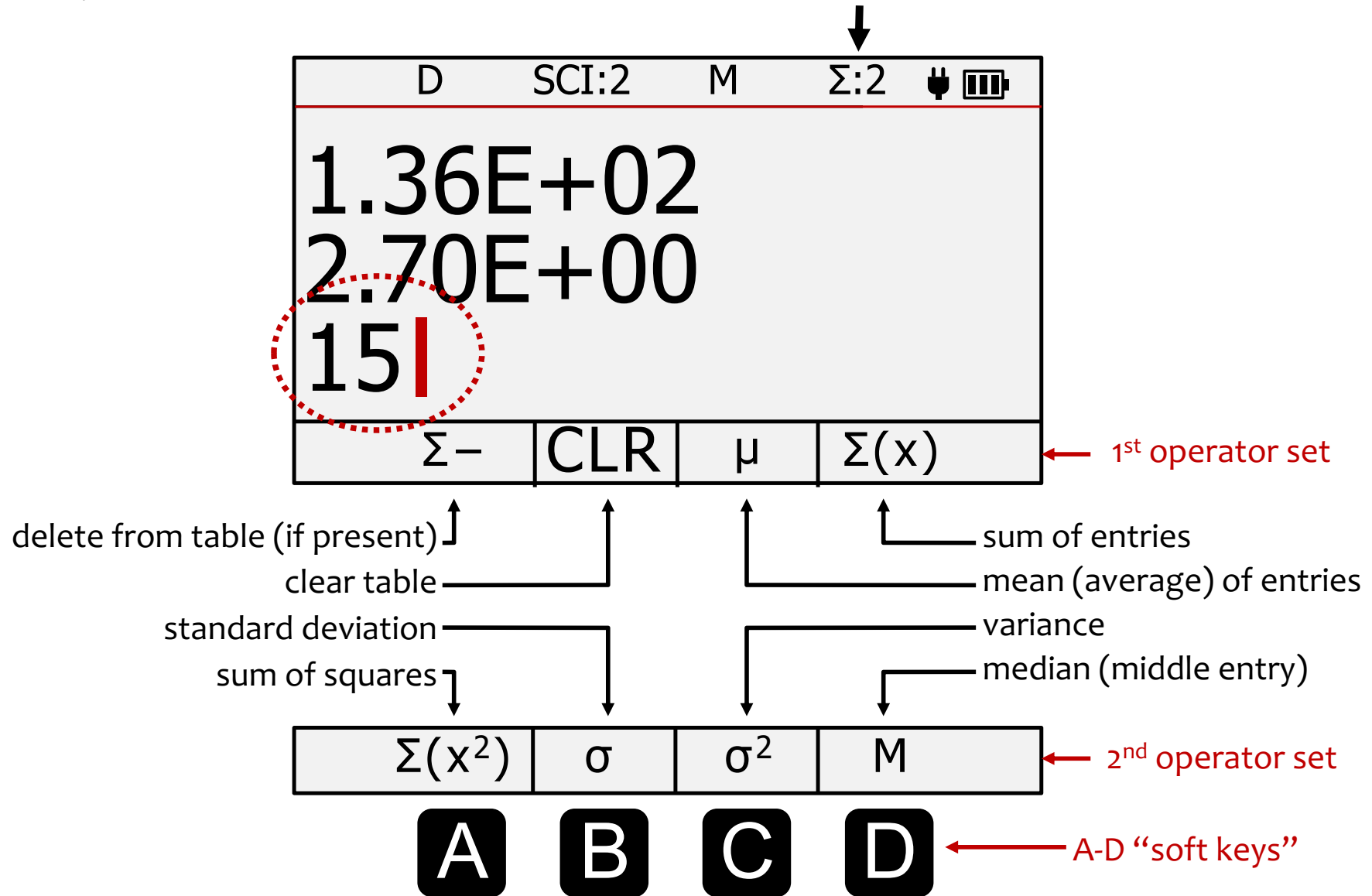

## Using the SciPlus-3500 to Evaluate Mathematical Functions

When you select the  $f(x)$  key, the display will look like the picture on the opposite page. The SciPlus-3500 enables you to enter and evaluate two different equations, “f1(x)” and “f2(x)”. Note that, while in functions mode, the following features of the SciPlus-3500 are not accessible:

- Fraction calculations
- $(x,y) \leftrightarrow (r,\theta)$  conversions
- DMS  $\leftrightarrow$  DD conversions
- Memory operations (the value stored in memory is maintained)
- Statistical operations (the statistics table is maintained)

When in  $f(x)$  mode, the three lines displayed each have unique meaning:

**Equation Line:** The top line shows the equation that is being evaluated. Note that equations are in the form  $y = f(a,b,c,x)$ , and can have up to four variables  $a$ ,  $b$ ,  $c$ , and  $x$ . Of course, convention normally considers  $a$ ,  $b$ , and  $c$ , to be “constants”,  $x$  the “independent variable”, and  $y$  the “dependent variable”.

**Results Line:** The middle line shows the result of the most recent calculation. This may be the entry (or query) of one of the variables  $a$ ,  $b$ ,  $c$ ,  $x$ , or the resulting value of the equation ( $y$ ) for a given set of input constants  $a$ ,  $b$ ,  $c$ , and a specific  $x$  value.

**Input Line:** This is the line in which you enter the equation using the various mathematical functions of the SciPlus-3500. You also enter values  $a$ ,  $b$ ,  $c$ , and  $x$ . Later, we will talk about how to determine one of these values if  $y$  is known.

The “soft keys” of the SciPlus-3500 have the following meaning while in functions mode:

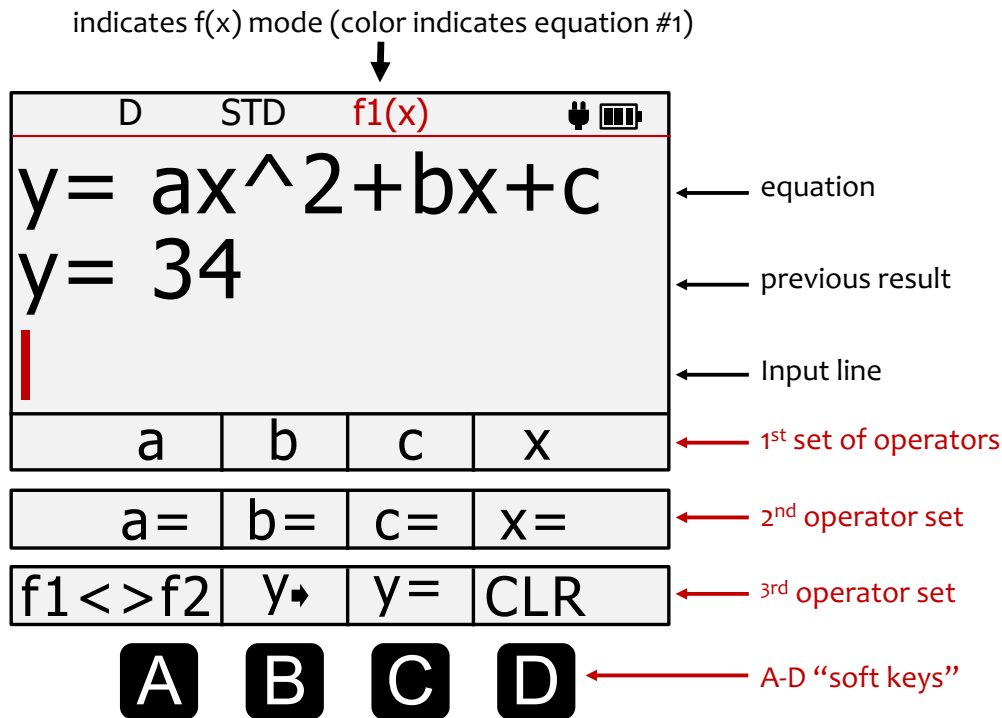

**First operator set:** Push  $f(x)$  once. The four soft keys allow you to use the variables  $a$ ,  $b$ ,  $c$ ,  $x$  to define a function in the form  $y = f(a, b, c, x)$ .

**Second operator set:** Push  $f(x)$  again. This second set of soft keys allows you to define values for the variables  $a$ ,  $b$ ,  $c$ ,  $x$ .

**Third operator set:** Push  $f(x)$  a third time. This third set of soft keys allows you to switch between equations  $f_1(x)$  and  $f_2(x)$ , enter and edit the equations, find  $y$ , and CLR all the stored information related to  $f(x)$  mode.

**Note:** In this section, softkey entries are shown in blue.

For example “ $y =$ ” means press **C** in the third softkey set.

## Calculating values of $f(x)$ :

Let's investigate how to use the SciPlus-3500 in functions mode by evaluating the expression:

$$y = ax^2 + bx + c$$

- Enter functions mode:** First, use the  $f(x)$  key to enter functions mode.
- Enter the equation:** Push  $f(x)$  two more times and select  $y = (C)$ . The bottom line of the display will show "y=". Now push  $f(x)$  again to get back to the variables list a, b, c, x. Enter the expression as follows using the soft keys:

$$y = a \ x \ \sqrt{x^2} \ + \ b \ x \ + \ c$$

**NOTE:** Remember that **D** represents "x"!

Once you press  the equation will be displayed in the top line. Of course, if the equation contains a syntax error, you will get an error message when you attempt to get a result.



For now, the middle line will remain blank.

- Entering values for the variables:** Push  $f(x)$  again so that the soft keys show "a=", "b=", etc. Now let's enter specific values for a, b, c and x as follows:

$$a = 3 \ \leftarrow \quad b = 2 \ \leftarrow \quad c = \text{TAN}^{-1} \ 45 \ ) \ \leftarrow \quad x = 3 \ \leftarrow$$

Note from the above example that it's perfectly acceptable to enter a variable as an expression (e.g. TAN(45)). Provided the expression can be resolved, it'll just enter the result as that variable.

You will notice that, as these values are entered, they appear in the middle "results" line.

At any time, you can query a variable by simply selecting the  key without a value or expression after the variable. For example, **a=**  will display “3” in the results line. If you have not yet entered a value for a, then “a=undefined” will be displayed in the results line.

You can always over write any variable with a new value.

- 4. What’s the answer?** Once all four variables have been entered, you can select **y=**  to show the result. The value of  $y = 3x^2 + 2x + \text{TAN}(45)$  for the value of  $x=3$  in the middle line (“34” in this example as shown).

If the equation contains a divide by zero condition, the result  $Y=\text{DIV0}$  will be displayed.

If you see “y=...” in the middle line, it means that not all of the necessary variables have been entered yet. Zero values must be entered as such.

- 5. Changing variables:** At any point, you can change one of the values of a, b, c, x by repeating step ‘3’ above. A new value of y will be calculated each time a variable is entered.

For example, to find the value of  $y=ax^2+bx+c$  for a new value of  $x=4$ , simply enter **x= 4**  .



- 6. Editing the equation:** To edit the equation, use **y→** to put the equation into the input line. Move the cursor to the location you wish to edit. Remember  removes operators from the equation.
- 7. Entering a new equation:** You can easily enter a new equation by repeating step 2 above. The values for a, b, c, x will remain unchanged until you change them as explained in step 3.
- 8. Clearing everything:** You can use **CLR** to clear all the constants as well as the equation and start fresh.

## Entering a second function:

You can enter a second function if you wish by selecting **f1<>f2**. You will notice that the status bar now indicates “f2(x)” in the second highlight color. When we learn graphing in the next section, you will see that the SciPlus will plot both equations, f1(x) is plotted using highlight color #1 and f2(x) is plotted using highlight color #2.

Note that the second function requires its own independent set of variables a, b, c.

## Exiting functions mode:

You can exit function mode by simply pressing  .

## Some guidelines while in functions mode:

- Note that you don't need to enter the equation first and the variables second. You can start by entering variables. If you enter variables that are not in the equation, they will be ignored. If you don't enter all the variables required by the equation, you will see “y=...” when you enter **y=** .
- You can also change the equation and keep the same variables.

## Graphing with Your SciPlus-3500

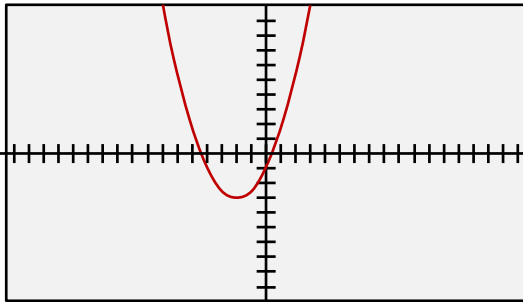

Use  $f(x)$  mode as described in the previous section to enter the following equation (**Note:** You may still have this function in the calculator’s memory from the previous section):

$$y = ax^2 + bx + c$$

Let’s use values for a, b, c as follows:  **$a=0.5$   $b=2$   $c=-1$**

Pressing  will display the graph shown at above. Note the default scales on the graph are as follows:





x-axis:  $x_{MIN} = -17$ ,  $x_{MAX} = 17$ ,  $x_{STEP} = 1$

y-axis:  $y_{MIN} = -10$ ,  $y_{MAX} = 10$ ,  $y_{STEP} = 1$

To exit graphing mode press  .

## Viewing the Graph

When you are viewing the graph, you can use     to move the entire graph.

If the cursor is turned on (see “Using the Cursor” below) and you press the soft key **C** (think “C for cursor”) you will notice that the crosshairs indicating the current cursor position will begin to flash. In this mode   moves the graph up/down as before, but   will now move the cursor left/right along the graph. Holding these keys down will cause the cursor to move more quickly. Pressing **C** again will turn this mode off.

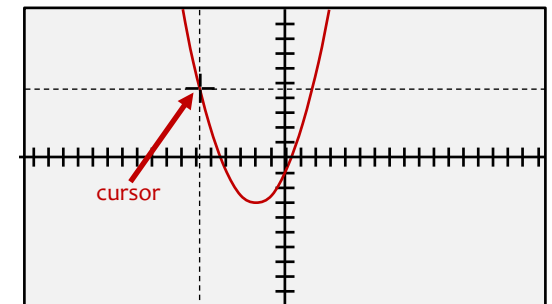

To zoom in/out on the graph, use the   keys.

**Note:** There is no speech or auditory output to describe graphs.

## Using the Cursor

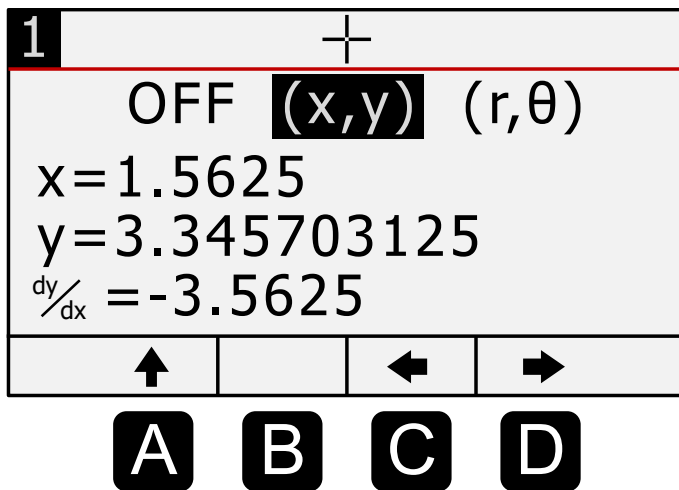

To display the cursor in the graph press  **1** and you will see the screen at left with the CURSOR icon at the top. Use **A** to navigate to the top line, and **C** **D** to select Cartesian coordinates (x,y) or polar coordinates (r,θ). Note that θ will be in the units for which the SciPlus is currently set (degrees, radians, gradians).

The next two lines indicate the value of x & y (or r & θ) for the current cursor position. You can the independent variable “x” to move the cursor to a new position. You cannot edit the independent variable “y”.

**Note:** You may only enter x values that are within the current displayed range. If you attempt to enter an x value outside this range, the SciPlus-3500 will default to a point close to the edge of the display.

**Note:** If you enter an x value for which there is no valid y value, the SciPlus-3500 will default to a nearby x value that is valid for the equation.

**Note:** You cannot edit the x value when in polar coordinates mode. This must be done from the graph itself, as described on page 27.

The last line  $\frac{dy}{dx}$  shows the slope of the graph at the current cursor location.

To view the graph, just press  again.



## Adjusting the Axes

There are three screens that you can use to manipulate the scales of the graph.

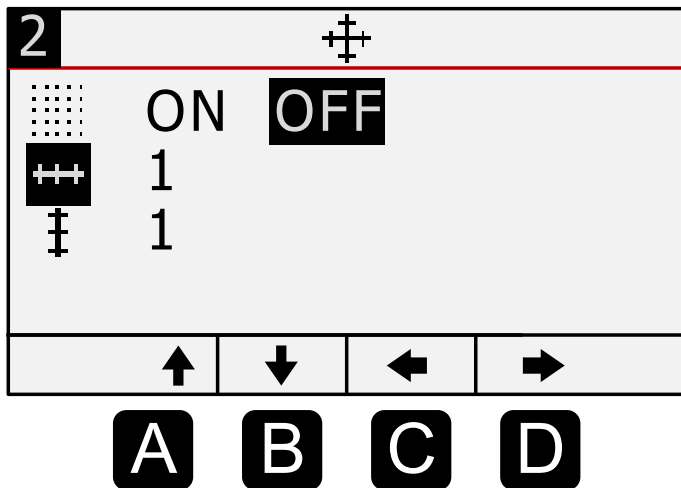

Press **2** or use to get to the second screen ( ).

On this screen you can turn the grid on/off. You can also adjust the size of the x and y tick marks.

To view the graph, just press again.

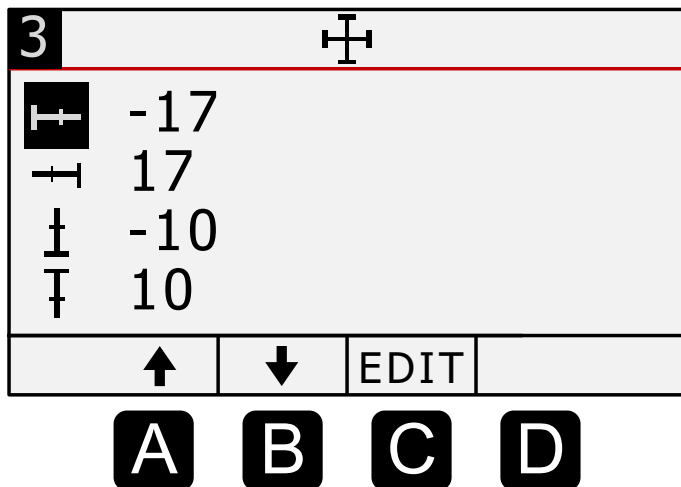

The third screen, indicated by the symbol, is used to manually adjust the range for the x and y axes. Note that the SciPlus will never allow you to enter a minimum value that is larger than the maximum value for the x or y axis. Use **A** **B** to select the axis end point you wish to adjust, and **C** to edit the value.

**Note:** If you are graphing a trigonometric function, the x axis values will be in degrees, radians, or gradians.  $\pi$  ( ) can be used to define x and y tick mark values and axis ranges

To view the graph, just press again.

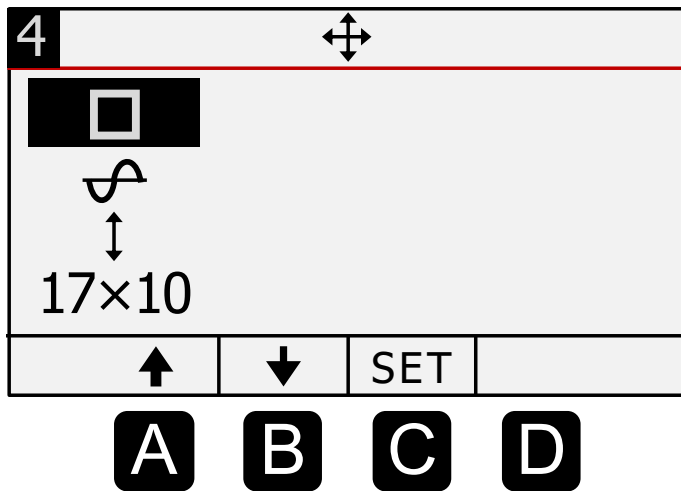

The fourth screen is the RANGE screen, indicated by . Here you can automatically set the size of the x and y axis as appropriate for the equation that is being graphed. The four settings are as follows:

- 1) **Square mode:** This mode sets the x and y axis ranges so that the grid lines and tick marks are square. The SciPlus-3500 optimizes the scales to show the graph in the most appropriate size.
- 2) **Trigonometry mode:** In this mode, the x-axis range is set to  $-360^\circ$  to  $+360^\circ$ ,  $-2\pi$  to  $+2\pi$ , or  $-400$  to  $+400$  gradians, depending on whether the SciPlus-3500 is set to D, R, or G.
- 3) **Auto-Y mode:** In this mode, the y-axis range is set so that the minimum and maximum points of the graph within the current x-axis range, occupy the vertical height of the display.
- 4) **17x10 mode:** The x-axis is set to the range of  $-17$  to  $+17$  and the y-axis to  $-10$  to  $+10$ .

**Note:** Sometimes the above selections will not show a meaningful picture of the graph. For example, if you set the graph to “17x10” mode for the equation  $y=\sin(x)$ , with the angle set to degrees, this will show a y-axis that is about 1 twenty times too large, and a x-axis that goes from be  $-17^\circ$  to  $+17^\circ$ , which is not suitable for this equation. Experiment to become familiar with which settings are most suitable for different types of equations.

## Solving for Zeros (Poles)

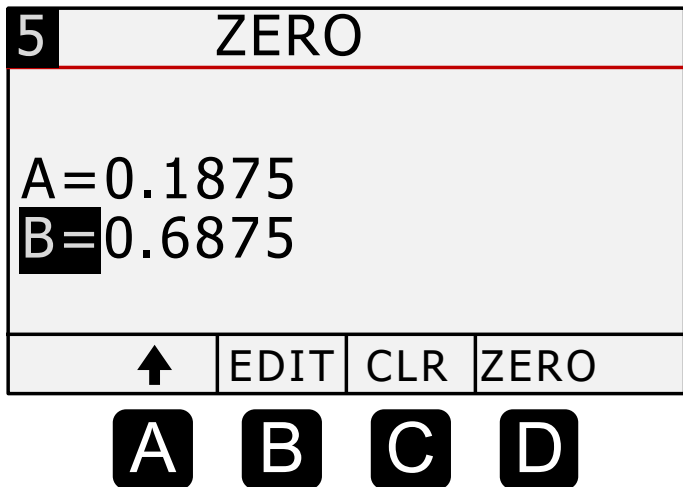

With the SciPlus-3500, you can find the points along a graph for which  $y=0$ . These are called the “zeros” or “poles” of a function. Note that some functions, such as a sine wave, will have multiple zeros. Others may have none.

To find a zero crossing or pole, you need to give the SciPlus-3500 a hint, by telling it two values along the curve near the zero. The easiest way to do this is by moving the cursor left/right (see “**Using the Cursor**” on page 28).

When you have the cursor slightly to the left of a pole, push the soft key **A**. Then move the cursor right, so that it is positioned just to the right of the pole and push the soft key **B**. This defines two x-values, one on either side of the pole.

Press  **5** to view the last screen, called “ZERO”, shown at right. You can see that the A and B x-values you selected when moving the cursor are displayed. You can also enter or edit values for A and B on this screen directly.



Now select “ZERO” ( **D** ) to solve for the zero value. The SciPlus-3500 will display the x-value at which the graph meets the x-axis ( $y=0$ ).

As always, just press  to return to the graph.

## A Graphing Example

Let's try an example using the same equation as before:  $y=0.5x^2 + 2x - 1$ . With the axis set to "17x10" mode this will display the graph shown on page 27. Let's first adjust the axes to get a closer look.

Press  **3** and change the x-axis range to -5 to +2.

Now press **4** to select the RANGE screen () . Select  and "SET" (**C**), which will set the y-axis range to maximize the size of the graph for the x-axis range you specified.

When you again press  you will see the graph at right. Notice that there are two zero crossings. Let's find the one on the right. First, make sure the cursor is flashing (**C**). Then, move the cursor just to the left of the zero as shown, and push **A**. This sets one of the two search limits for the zero-finding algorithm. Now, move the cursor just to the right of the zero and push **B**.

Now press  **5** to get to the ZERO screen. It will appear something like the picture at right (the A and B values may be slightly different). If you now press "ZERO" the SciPlus-3500 will find the x-value for the right zero crossing. You should see  $x=0.4494897428$ .

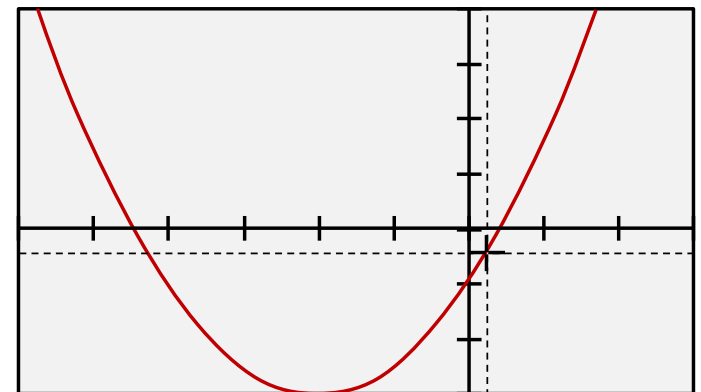

<b>5</b>	ZERO		
A=0.271875			
<b>B</b> =0.621875			
	EDIT	CLR	ZERO
<b>A</b>	<b>B</b>	<b>C</b>	<b>D</b>

## Plotting two lines $f_1(x)$ and $f_2(x)$

Recall that in  $f(x)$  mode while entering a functions, the softkey **f1<>f2** ( **A** in the third softkey set) enables you to switch back and forth between two functions  $f_1(x)$  and  $f_2(x)$ . If two functions have been entered they will both appear when you display the graph(s).  $f_1(x)$  will be shown in highlight color #1, and  $f_2(x)$  in highlight color #2.

The picture below shows two simple functions:

$$f_1(x): y = (1/2)x^2 - 1$$

$$f_2(x): y = 3x - 1$$

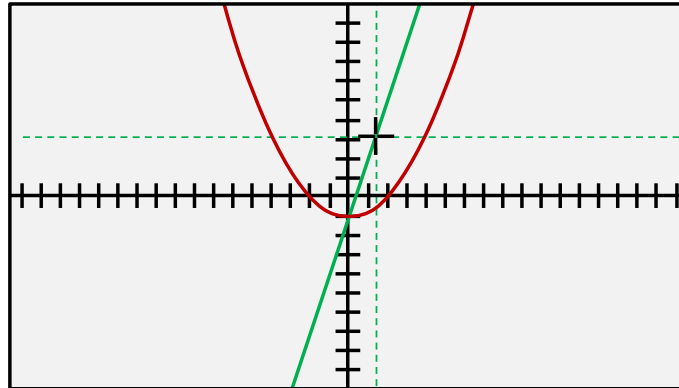

**Note:** In the picture above the cursor is shown using green lines. This indicates that  $f(x)$  mode is currently set for  $f_2(x)$ . All the graph attributes (scale settings, solving for zeros, cursor settings, etc.), are set for  $f_2(x)$ . To switch back to  $f_1(x)$  return to  $f(x)$  mode and select softkey **f1<>f2**.



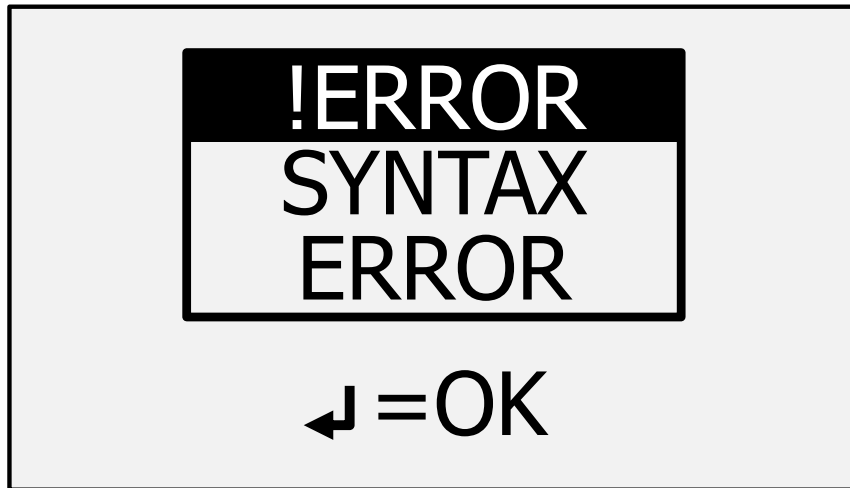

**Note:** When two graphs are plotted, the softkey **D** causes the cursor, if activated, to alternate between  $f_1(x)$  and  $f_2(x)$ .

## Errors



Sometimes you'll enter things incorrectly, such as not closing a bracket or dividing by zero. In this case, you'll get a **SYNTAX ERROR** message like the image at left.

You might see other types of error messages such as "INVALID ARGUMENT" or "INFINITE RESULT".

To remove this message simply press . This returns you to the entry line. Use the    keys to correct the error.

### Troubleshooting

#### **Battery does not recharge:**

The SciPlus battery may fully discharge after a month or more of inactivity. Simply plug in the calculator as if to recharge, for about half an hour. Next, perform a reset by inserting a paper clip into the small hole on the underside of the calculator, and gently push until you hear/feel a small click. Then keep the calculator plugged in at least overnight to fully recharge.

If a reset does not resolve the problem, determine whether it is an issue with the USB charger or cord by attempting to recharge with another USB charger and /or cord.

#### **SciPlus calculator is acting erratically:**

Perform a reset by inserting a paper clip into the small hole on the underside of the calculator, and gently push until you hear/feel a small click.

#### **The SciPlus has no sound:**

The SciPlus-3500 is designed to be used with earbuds or speakers. There is no external speaker. Refer to “Speech Output” to ensure the sound is turned on and set to the proper volume. If there is still no sound, check to ensure you are using working earbuds, and that any volume dial on the earbuds is turned up.

## Service

If for any reason you require service or support for your SciPlus-3500, please contact the authorized dealer from whom it was purchased.

If you purchased directly from Sight Enhancement Systems, contact **service@sightenhancement.com** and include the following information:

- The serial number of the SciPlus-3500 (see the label on the underside of the calculator).
- A description of the problem.

The robustness of Sight Enhancement Systems SciPlus calculator is legendary, and you should enjoy years of reliable operation

## Warranty

The SciPlus-3500 is covered by a one year limited warranty from the date of purchase. Warranty includes parts, labour and shipping costs. Goods may be returned only upon authorization by Sight Enhancement Systems. Warranty covers "normal wear and tear", and does not cover damage resulting from obvious misuse of the product. Examples of misuse include, but are not limited to, damage due to exposure to moisture or extreme heat, damage due to dropping the device, and physical damage to connectors and plugs.





Copy downloaded from  
[www.sightenhancement.com](http://www.sightenhancement.com)

For a high-quality spiral bound copy please  
contact Sight Enhancement Systems



sight  
enhancement  
systems

364 Huron Avenue South  
Ottawa, Ontario  
K1Y 0W7  
CANADA

[www.sightenhancement.com](http://www.sightenhancement.com)